



Operating instructions

(Translation of the original operating instructions)

LFE 101 ST1

LFE 201 ST1

LFE 301 ST1

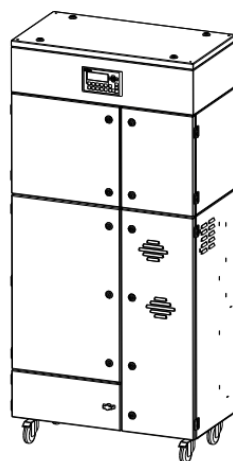

Table of contents

1. General	4
2. Description of the system elements	5
2.1. Illustration of the system elements	5
2.2. Functionality of the system	6
2.3. Intended use	6
2.4. Residual risk	6
3. Safety instructions	7
3.1. Definition of the hazard symbols	7
3.2. General safety instructions	7
4. Storage, transport and installation of the device	8
5. Commissioning	9
5.1. Connecting the suction line and exhaust air line	9
5.2. Electrical connection	10
5.3. Coating of the filter cartridges with cartridge protection	10
5.4. Connecting the compressed air supply	11
5.4.1. Compressed air supply for the cleaning of the filter cartridges	11
6. Operating the system	12
6.1. Explanation of the operating elements	12
6.2. Connection of an external control	13
7. Maintenance	14
7.1. Reset to maintenance state	15
7.2. Cleaning the filter cartridges	15
7.3. Replacing the filter cartridges	16
7.4. Emptying the dust collecting tank	18
7.5. Draining the condensate	20
7.6. Coating of new filter cartridges with cartridge protection	21
7.7. Replacing the particle filter	22
7.8. Replacing the activated carbon / the activated carbon cassette	24
7.8.1. Replacing the activated carbon	24
7.8.2. Replacing the activated carbon cassette	27
7.9. Replacing the cooling air filters of the turbines	28
7.10. Replacing the filter mats for the air outlet grille	28
7.11. Cleaning/replacing the particle sensor	29
7.12. Check/replace the dust filters for underpressure measurement lines	30
8. ATEX operation	31
8.1. ATEX zoning	31
8.2. Sources of ignition	33
8.2.1. Evaluating the risk of ignition in accordance with DIN EN 80079-36	33
9. Dismantling / Disposal	33
10. Diagnostics and troubleshooting	34

11. List of spare parts	35
12. Technical data	36
13. EC declaration of conformity	37
14. ATEX Annex to the EC declaration of conformity	38
14.1. ATEX devices	38
14.2. ATEX components	38
15. Training protocol	40
16. Maintenance intervals	41
16.1. Usage-related maintenance	41
16.2. General maintenance	42
16.2.1. Visual inspection of the device	42
16.2.2. Visual inspection of the pipelines for dust deposits	43
16.2.3. Visual inspection of the pneumatic pipes	43
16.2.4. Functional test of the device	43
16.2.5. Electrical test of the electrical lines and earthing connections	44
16.2.6. Test of fixing of the mounted unit elements	44
17. Annex A: ATEX conductivity measurement protocol	45

1. General

Congratulations on purchasing the product from TEKA.

Our engineers ensure that our devices reflect the state of the art through continuous development. Nevertheless, misuse or misconduct can endanger your safety. Please observe the following for a successful use of the device:

	<p>Only authorised and instructed personnel can carry out transport, operation, maintenance and repair of the device. The operator must ensure that the operating personnel take note of these instructions.</p> <p>Please read these instructions before operating the device, and observe the safety precautions to avoid injury!</p> <p>Store this manual in a safe place! These instructions are to be regarded as a component of the product!</p> <p>Adhere to all product notes!</p> <p>Modifications or conversions that the operator carries out at the device without the consent of the manufacturer, can lead to new safety hazards or to the loss of warranty claims.</p> <p>Observe the manufacturer's instructions. Contact the manufacturer in case of any uncertainty: Tel: +49 2541-84841-0 E-mail: info@teka.eu</p>
---	---

2. Description of the system elements

2.1. Illustration of the system elements

Installation example:

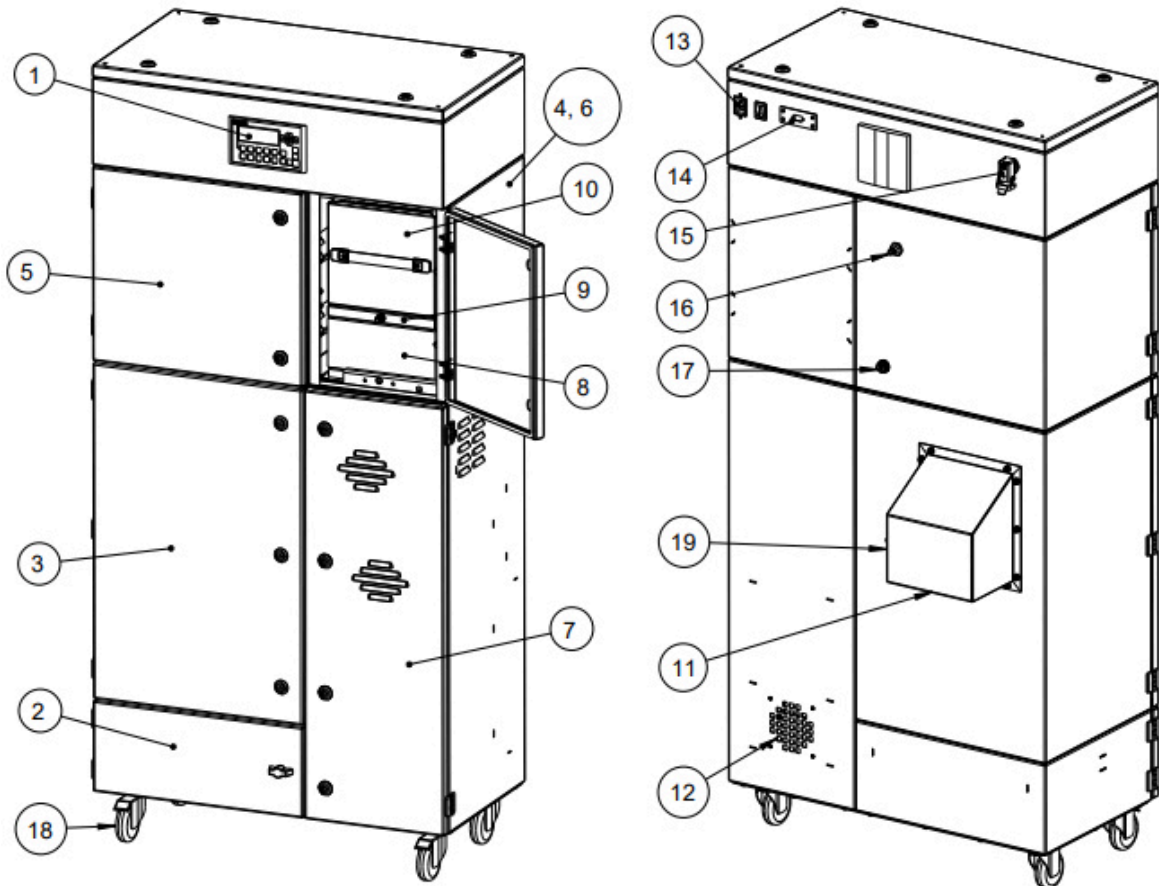

Z.Nr. 14261701

Pos.1	Operating panel of the control	Pos.11	Suction nozzle
Pos.2	Dust collecting housing	Pos.12	Exhaust grille
Pos.3	Filter housing	Pos.13	Connection for mains cable
Pos.4	Particle filter housing	Pos.14	Connection for external control unit
Pos.5	Cleaning housing	Pos.15	Industrial connector for the optional gate valve
Pos.6	Activated carbon housing	Pos.16	Connection for compressed air
Pos.7	Turbine housing	Pos.17	Drain valve for compressed air
Pos.8	Particle filter	Pos.18	Swivel castor
Pos.9	Intermediate frame	Pos.19	Connection for Metering device
Pos.10	Activated carbon cassette		

2.2. Functionality of the system

The filter unit serves to suck off and filter polluted air (according to the intended use). The air is purified on the surface of the filter cartridge in the filter section of the unit. The separated dust is collected in a dust collecting tank. The activated carbon filter absorbs gases and unpleasant odours. The subsequent particle filter cleans even fine smokes and dusts. An automatic filter monitoring indicates when a cleaning or a replacement of the filters is necessary. The purified air is led back into the working room via an exhaust air grille.

2.3. Intended use

The device is intended for commercial use. If the device is made publicly accessible, it must never be operated unsupervised by authorized personnel, authorized by the operator.

The intended use of the filter unit is the application combined with laser devices and especially the extraction and filtration of dusts, fumes and gases.

The filter unit can be used to extract explosive dusts with the following characteristic values (for further information, see the section on "ATEX operation"):

Kst value	<200 bar*m/sec
MIE (<i>minimum ignition energy</i>)	>10 mJ
Combustibility index	≤ 2
Dust group	IIIB

	WARNING
	<p>Improper use can damage parts and be a danger to life and limb! The device must not be used for the extraction of oil-laden welding fume, explosive gases, hybrid mixtures, glowing or burning substances, gases, water, etc. The device must not be operated in explosive zones.</p> <hr/> <p>Dangers arising from fire. If the sucked medium is combustible fume or dust, the operator must determine beforehand which fire protection measures are to be taken.</p>

2.4. Residual risk

	CAUTION
	<p>Danger due to possible hazardous materials in the exhaust air flow. Because the unit does not monitor the quality of the air in the exhaust air flow, we recommend that you always guide the exhaust air flow exiting our unit to areas (e.g. to the outside into the open air) in which there is no danger to any living being. To do this, it is necessary to fit a suitable exhaust air line at the filter unit.</p>

3. Safety instructions

3.1. Definition of the hazard symbols

The device is constructed according to the state of the art and the recognised safety regulations. Nevertheless, during use threats to life and limb of the user or other persons may arise. The impairment of the machine or other property are also possible. In these instructions we warn by using corresponding indications.

	WARNING
	<p>WARNING These instructions are made in case of risks that can lead to <u>injury or death</u>.</p>

	CAUTION
	<p>CAUTION These instructions are made in case of risks that can lead to <u>injury</u>.</p>

	NOTICE
	<p>NOTICE These instructions are made in case of risks that can lead to <u>material damages</u>.</p>

	Information notes are no hazard warnings; they call attention to useful information.
---	--

3.2. General safety instructions

	WARNING
	<p>Dangers arising from improper use / unauthorised operations. The operator must ensure that their authorised personnel are familiar with all the safety indications in this manual in advance. The operator is responsible for ensuring that all work is carried out by authorised and qualified personnel. We therefore recommend using the training protocol on the last page for that purpose (see chapter "Training protocol"). Laymen are allowed to operate the device after having received the necessary instructions. But they are not allowed to carry out any installation, repair or maintenance work.</p> <hr/> <p>Dangers arising from fire. In case of fire, if possible, switch the unit immediately off or disconnect it from the power supply. Fire extinguishing measures which the operator is obliged to determine beforehand must be initiated immediately. The device is additionally equipped with a particle sensor, which can detect an increase of the particles (eg due to fire, filter break, ...) within the device. The particle sensor thus provides a monitoring of the particulate matter, but does not provide 100% protection for the detection of a fire. When the particle sensor is triggered, the device switches off.</p>

	WARNING
	Dangers arising from electricity. The operator must ensure that electrical plants and equipment are only built, modified and maintained by a qualified electrician or under the direction and supervision of a qualified electrician. Do not work on components if you are not sure that these are disconnected. If necessary, disconnect the device from the electric power supply and secure it against unauthorized restarting.

	WARNING
	Explosion hazard! Do not operate the unit if any components are defective, missing or damaged. Check the orderly condition of the unit before switching it on. The unit must not be operated without a filter element.

4. Storage, transport and installation of the device

	WARNING
	Risk of injury from tilting or unmounted components when stored or transported. The device must be secured against tilting and slipping when it is stored or transported. Do not stand under or next to the floating load. Lift trucks, forklift trucks and transport cranes must have a sufficient minimum load bearing capacity. Pay attention to uneven grounds during the transport. Avoid jerky pushing. <hr/> Dangers arising from titling or functional impairments at its destination. The unit may only be set up on a suitable surface. The surface must be vibration-free and horizontal. The operator must check the bearing capacity of the surface. As soon as the unit has reached its intended destination, the brakes of the castors must be activated.

	WARNING
	Explosion hazard! The installation location for the filter unit must be examined for potential lightning impacts. If the possibility of these cannot be excluded then the filter unit must be taken into consideration in the Operator's lightning protection concept.

	NOTICE
	Damage or functional impairment of the unit due to climatic influences. The unit must be stored in a dry place and protected against moisture during transport. As a matter of principle, the filter unit is not designed to be installed outside.

5. Commissioning

	WARNING
	<p>Dangers arising from a defective condition of the unit. Make sure that the measures described in this chapter are completed before the commissioning of the unit. All doors of the unit must be closed and all necessary connections must be attached before turning the unit on. Do not operate the unit if any components are defective, missing or damaged. Check the orderly condition of the unit before switching it on. The unit must not be operated without a filter element.</p>

	WARNING
	<p>Increased risk of explosion when filter unit switched off. If the filter unit is left switched off while work is performed at the extraction points then dust may collect at the extraction points. If the dusts in question are potentially explosive then this increases the risk of explosion. In its risk assessment for the overall system, the Operator must therefore ensure that</p> <ol style="list-style-type: none">1) the filter unit is switched ON before any dust/fume-generating work is performed,2) dust/fume-generating work is ceased promptly when the filter unit is switched OFF either voluntarily or due to a fault message. <p>The Operator must also note whether shut-off valves are present between the extraction point and the filter unit. These must be open while the work is being performed.</p>

	NOTICE
	<p>Damaged supply lines. Make sure that the supply lines are protected against damage by forklift trucks and similar events. Protect all supply lines from heat, moisture, oil and sharp edges.</p>

5.1. Connecting the suction line and exhaust air line

For extracting the contaminated air, a suction line must be connected to the suction nozzle (see chapter 2.1).

	WARNING
	<p>Explosion hazard! The lines must be kept as short as possible and must be laid to the extraction point in a way that optimizes the flow in order to prevent any deposits from forming in the lines. TEKA Absaug und Entsorgungstechnologie GmbH expressly draws your attention to the fact that extraction lines that have not demonstrably been configured by TEKA are not covered by the filter unit's explosion protection documentation. These must be configured for the application in question. The conductivity of suction lines must be checked in order to prevent static charges from building up. Leakage resistances $< 10^6$ Ohm must be ensured.</p>

If the air shall be directly sucked off by an upstream machine, the suction line must be connected to the capture opening of the upstream machine.

The purified air is led back into the working environment via the exhaust air grille (see chapter 2.1) (recirculation mode). If it is desired to lead the purified air out of the working environment, an exhaust air pipe must be attached at the discharge grille.

5.2. Electrical connection

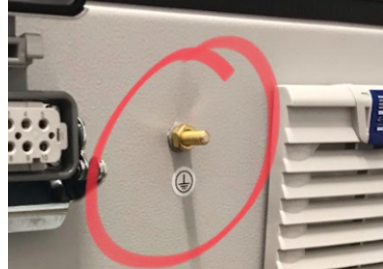
	WARNING
Explosion hazard! The conductivity of suction lines and system parts must be checked in order to prevent static charges from building up. Leakage resistances $< 10^6$ Ohm must be ensured. The Operator must ensure the equipotential bonding of the unit. To do this, use the earthing point on the back of the unit.	
	

	CAUTION
Health hazard arising from unintentional cleaning processes. Switch on the control only if the unit is in operational condition.	

	NOTICE
Electric malfunction possible in cause of an incorrect power supply. Pay attention to the admissible supply voltage. Please observe the specifications on the type plate.	

- Connect the mains cable (see chapter 2.1) to the power supply.

5.3. Coating of the filter cartridges with cartridge protection

For a longer service life of the filter cartridges, the new filter cartridges can be coated with a cartridge protection. However, this is not necessary when using nano filter cartridges.

WARNING Explosion hazard due to static charging of the filter cartridges. Coating is only admissible with slack lime "NANNOX L52".

	Please read and refer to "Coating of new filter cartridges with cartridge protection" in the chapter "Maintenance". There you can also find a description of the operating method of the cartridge protection.
---	--

5.4. Connecting the compressed air supply

	NOTICE
<p>The compressed air must be dry and oil-free. According to ISO 8573-1:2010 the compressed air quality must at least meet: [7:4:4]</p> <ul style="list-style-type: none">→ Partikle size: <math><40\mu\text{m}</math>→ Pressure dew point: $\leq +3^{\circ}\text{C}$→ Oil content: $\leq 5\text{mg}/\text{m}^3$	

5.4.1. Compressed air supply for the cleaning of the filter cartridges

The filter cartridges of the system are automatically cleaned. Cleaning is carried out pneumatically via a built-in compressed air tank.

	Without compressed air supply the filter cartridges will become dirty very quickly.
---	---

- The external compressed air supply must be assured with an approved compressed air hose. For the connection to the device, the compressed air hose must be equipped with a quick coupling for an insert sleeve DN 7.2.

NOTICE The compressed air must be dry and oil-free.

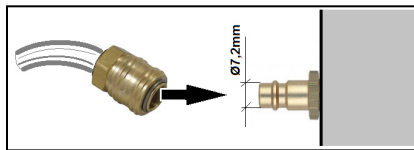

- The operating pressure of the compressed air supply must be a minimum of 3 bars and maximum of 4 bars.

NOTICE In case of the pressure being too low, the compressed air tank does not reach quickly enough the operating pressure for the following cleaning. There is a risk of material damage when the pressure is too high.



- Connect the compressed air hose to the insert sleeve (see chapter 2.1).

6. Operating the system

	WARNING
<p>Increased risk of explosion when filter unit switched off.</p> <p>If the filter unit is left switched off while work is performed at the extraction points then dust may collect at the extraction points. If the dusts in question are potentially explosive then this increases the risk of explosion. In its risk assessment for the overall system, the Operator must therefore ensure that</p> <ol style="list-style-type: none"> 1) the filter unit is switched ON before any dust/fume-generating work is performed, 2) dust/fume-generating work is ceased promptly when the filter unit is switched OFF either voluntarily or due to a fault message. <p>The Operator must also note whether shut-off valves are present between the extraction point and the filter unit. These must be open while the work is being performed.</p>	

6.1. Explanation of the operating elements

	<p>Control functions, setting options for programs, menu navigation, error messages, etc. are described in the enclosed operating manual of the unit control. There is also an explanation of the elements of the control panel.</p>
---	--

Operating elements for the device control		
Representation	Designation	Description / function
	ON-OFF-switch	<p>By means of this switch, the device is switched on and off.</p> <p> When the device is switched off, it is <u>not</u> disconnected from the power supply.</p>

6.2. Connection of an external control

There is the possibility to control the unit from extern. For this purpose, a connection is provided on the unit (see chapter 2.1).

Connection plug type:	Industrial connector
Number of pins:	10

Pin-Nr.	Designation	Explanation
1, 2	Start contact	In order to switch on the filter unit, a contact has to be connected between pin 1 and pin 2. The unit is switched out when the contact is opened.  When the follow-up time is activated, the unit switches off after the preset period of time.
3, 4	External message "Fault"	Pin serves for the evaluation of an fault indication. (NO: normaly open)
5, 6	External message "Operation"	Pin serves for the evaluation of the operational control. (NO: normaly open)
PE	Protective earthing	Potential equalisation

7. Maintenance

In accordance with national regulations, the operator is obliged to carry out repeat and functional tests. Unless otherwise specified by national regulations, we recommend regular visual inspections and functional tests of the device as described in the chapter “Maintenance intervals”.



You find the chapter “Maintenance intervals” at the end of the document. The general maintenance (visual inspection, etc.) is also explained there.

In the chapter “Maintenance intervals” there is information on the maintenance intervals of the filter elements. But these are only recommendations. Depending on the application (multi-shift operation, dust generation, ...) it may be necessary for the operator to change the maintenance intervals.

In this chapter the maintenance work which is caused by wear caused during operation is described.



WARNING

Work on the open system entails the risk of electrical shock or accidental restart the system. Both pose a danger to life and limb.

When cleaning and servicing equipment during the replacement of parts or when changing to another function, set the device to maintenance condition first (see chapter “Reset to maintenance state”).

A recommissioning of the device must only occur if it is ensured that the device is functionally equivalent to the original state.

Dangers to life and limb when non-original spare parts are used

Only original TEKA spare parts must be used.



WARNING

Explosion hazard due to dust formation.

Avoid whirling up deposited dust during all maintenance work. Keep away possible ignition sources from the installation at any time. Use suitable tools to clean and to bond dust during cleaning work. The maintenance personnel must ensure that static discharges are avoided during work at the unit.



CAUTION

Hazards to the respiratory tracts are possible.

All maintenance work must only be carried out in well-ventilated rooms and while wearing an appropriate respiratory mask! We recommend: respiratory protection half mask DIN EN 141/143 protection level P3. For all maintenance work ensure a cautious handling of filter elements and components in order to avoid whirling up dust.



The operator is obliged to store and dispose of the collected dust in accordance with national or regional regulations. For all maintenance or cleaning work please refer to the applying environmental regulations. Pollutants and filter elements must be disposed of or stored according to the regulations as well. If you have any doubts, we recommend contacting a disposal contractor in your area.

7.1. Reset to maintenance state

- Switch off the unit. Unplug the mains plug. Secure the unit against unauthorized restarting during maintenance.
- Disconnect the compressed air hose of the external compressed air supply from the insert sleeve (see chapter 2.1).
- Empty the compressed air tank by opening the drain valve (see chapter 2.1) with a suitable screwdriver. Minor quantities of condensation water can leak out when opening the drain valve. Close the drain valve when the compressed air tank is entirely empty.
CAUTION When opening the drain valve a jet of compressed air can occur.
- After completion of all maintenance work the unit can be reconnected to the power supply and the external compressed air supply.

7.2. Cleaning the filter cartridges

	CAUTION
<p>A sudden jet of compressed air and huge amounts of whirled up dust are possible due to an automatic cleaning with an opened service door.</p> <p>During the operation of the device, the service door of the filter housing must not be opened. The same applies to the ready to operate condition (standby) as there is also the possibility of an automatic cleaning (subsequent cleaning).</p>	

The filter cartridges are reusable filters and can be cleaned. The cleaning of the filter cartridges is automatically carried out.

The degree of pollution of the filter cartridges is electronically monitored. In order to assure the required extraction capacity of the device, the cleaning of the filter cartridges starts automatically when a preset differential pressure value is reached. If the preset differential pressure value is not undercut after the cleaning of the filter cartridges, another cleaning starts. The filter unit remains in operation during the automatic cleaning. The compressed air blast is produced in opposite direction to the intake. The cleaned dust falls downwards in the dust collecting tank.



Depending on the setting of the control unit there can be automatic postcleanings of the filter cartridges even when the unit is switched off.

When the maximal admissible differential pressure value is reached, the device triggers an alarm (see chapter "description of the control elements"). If despite of the automatic cleaning of the filter cartridge the alarm value is not undercut anymore, the filter cartridge must be replaced. (see chapter: "Replacing the filter cartridges").

The differential pressure values in the control unit that initiate a cleaning or a filter alarm are preset values adapted to the filter unit. Please find detailed information concerning the functioning in the enclosed operating instructions of the control unit.

7.3. Replacing the filter cartridges

Replacing the filter cartridges becomes necessary when the filter cartridges are saturated with dirt in a manner that despite of the cleaning the filter alarm is triggered again at very short intervals or permanently. (The filter alarm is described in chapter "Cleaning the filter cartridges".)

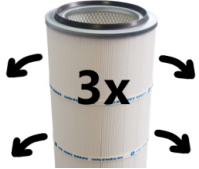
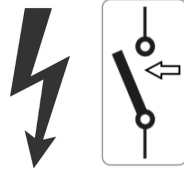
	CAUTION	Whirling up dust is possible due to the polluted filter cartridges. Danger of unintentional automatic cleaning with the unit switched off.				
	<p>The filter cartridges must be cleaned before being replaced. This is done by carrying out 3 manual cleanings via the unit control (see separate operating instructions). The filter unit must be switched off beforehand but without disconnecting the unit from the power supply. After the cleaning, disconnect the filter unit from the power supply and secure it against being switched on again. After cleaning the filter cartridges wait about 5 minutes before opening the service door of the filter housing.</p>					

We recommend using a disposable protective suit when changing the filter cartridges.



For a longer service life of the filter cartridges the new filter cartridges can be coated with cartridge protection. However, this is not necessary when using nano filter cartridges. If you wish to coat the new filter cartridges nevertheless, please refer to the indications in the chapter "Coating of new filter cartridges with cartridge protection". There you can also find a description of the operating method of a cartridge protection.

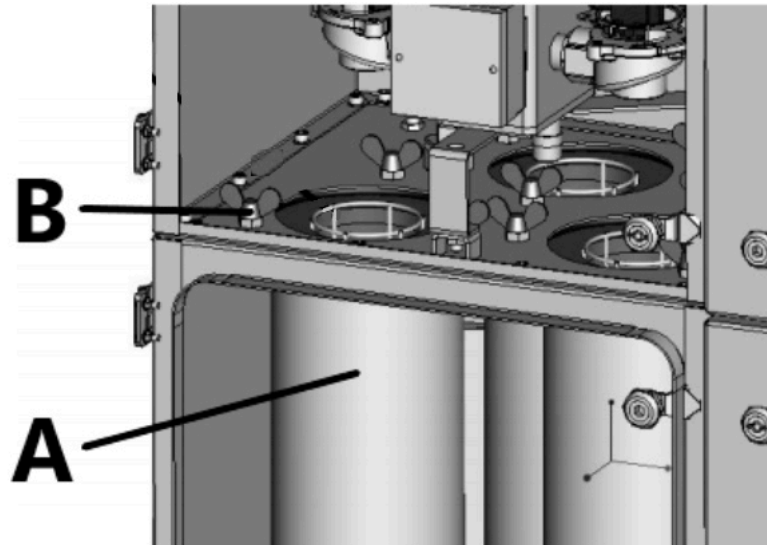

- Before changing the filter cartridges hold ready an appropriate container (e.g. PE bag) for disposal.

CAUTION The polluted filter cartridges must be packed into an appropriate container (e.g. PE bag). PE bags are optionally available (see list of spare parts)! We recommend having disposal bags in stock.

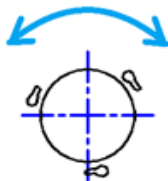

- Open the service door of the filter cartridges. Also open the service door of the cleaning housing. This is only possible by means of a special electrical spanner.
- Slip the disposal bag from bottom to top over the filter cartridge (A).
- Unfasten the 3 thumb screws (B) of the filter cartridge by turning them clockwise.
- Grab the filter cartridge and turn it a little clockwise to disconnect it from the screw fastening. Therefore do not touch the filter cartridge directly with your hands, but grab it from the outside through the bag.





- Carefully close the disposal bag (e.g. with a cable fastener) and store or dispose of it together with the polluted filter cartridge in an appropriate container according to the regulations.
- Insert the new filter cartridge into the screw fastening and turn it anticlockwise to the hilt.
NOTICE Only use TEKA spare filters. Otherwise the proper functioning of the unit is not guaranteed, and there is a danger to life and limb.
- Hand-tight screw the 3 thumb screws.
- Carry out this procedure for all filter cartridges.
- Close the service door.

7.4. Emptying the dust collecting tank

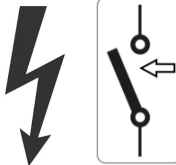
The dust collection container must be cleaned after a certain number of operating hours. This range depends on the amount of dust. The dust collecting tank may only be filled up to a maximum of 25%. The filling level has to be proofed at least once a week.

	CAUTION	Whirling up dust is possible due to the polluted filter cartridges! Danger of unintentional automatic cleaning with the unit switched off.					
	<p>The filter cartridges must be cleaned before emptying the dust collecting tank. This is done by carrying out 3 manual cleanings via the unit control (see separate operating instructions). The filter unit must be switched off beforehand but without disconnecting the unit from the power supply. After the cleaning, disconnect the filter unit from the power supply and secure it against being switched on again. After cleaning the filter cartridges wait about 5 minutes before opening the service door.</p>						

	WARNING			
	<p>Explosion hazard! During the discharge process, there must not be any effective sources of ignition in the vicinity of the dust collecting container. The maintenance personnel must ensure that static discharges are avoided during work at the unit.</p>			
		<p>Explosion hazard! No bags may be placed in the dust collecting container (risk of build-up of static charges).</p>		

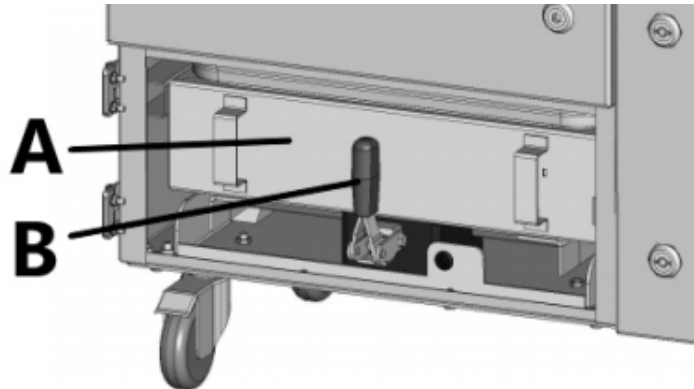

- Open the service door of the dust collecting housing (see chapter 2.1).
- Release the two earth connections.

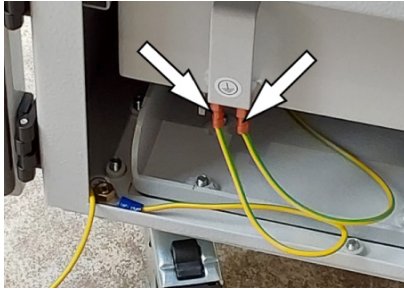

- Release the clamping lever (B) of the dust collecting tank (A).
- Carefully pull the dust collecting tank out of the housing.
- Empty the dust collecting tank into an appropriate, closable container or bag. Dispose of or store the dust according to the regulations.
- Push the dust collecting tank back into the dust collecting housing.
- Manipulate the clamping lever so that the dust collection container is pressed tightly against the above housing.
- Re-establish the two earth connections.

⚠WARNING There is a risk of explosion during operation if an earth connection is not attached.

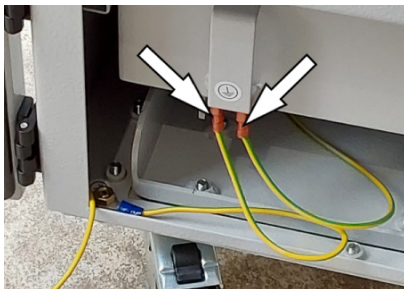

- Close the service door.

7.5. Draining the condensate

Operation with compressed air can result in condensation water being gradually deposited in the compressed air tank. The condensed water must be emptied regularly. The maintenance interval depends heavily on the quality of the compressed air and cannot, therefore, be determined in advance.

	CAUTION
When opening the drain valve a blast of compressed air is possible. Open the drain valve slowly.	

- Empty the compressed air tank by opening the drain valve (see chapter 2.1) with a suitable screwdriver. Let the escaping condensate flow into a suitable container.





- Close the drain valve.

7.6. Coating of new filter cartridges with cartridge protection

Before the first commissioning new filter cartridges can be coated with cartridge protection. The cartridge protection assists against a "caking" of extracted particles on the filter surface and thus prolongs the life of the new filter cartridge.

⚠️WARNING Explosion hazard due to static charging of the filter cartridges. Coating is only admissible with slack lime "NANNOX L52".

Unlike with other maintenance work, this step must be carried out with the system switched on and operating. This is necessary to allow the cartridge protection to disperse on the surface of the filter cartridges through suction.

	CAUTION	
	<p>On contact the cartridge protection can be hazardous to the respiratory tract and cause skin irritation or eye irritation. Only use TEKA cartridge protection. Non-compliance can result in dangers to life and limb.</p> <p>Observe the listed manufacturer instructions provided:</p> <p><i>Handling:</i> Avoid the formation of dust!</p> <p><i>Storage:</i> Seal the container tightly before storage!</p> <p><i>Respiratory protect:</i> Dust mask without protection level!</p> <p><i>Hand protection:</i> Protective gloves in cloth, rubber or leather!</p> <p><i>Eye protection:</i> Safety glasses with side shields!</p> <p><i>Body protection:</i> Anti-static work shoes!</p>	

	CAUTION
	<p>During operation of the device an automatic cleaning can take place. This involves the risk of a sudden jet of high-pressure air and excessive dust formation at the point of entry of the cartridge protection.</p> <p>At first make sure that there is no compressed air in the compressed air tank. Please refer to the chapter "Reset to factory settings". Before switching the device back on, disconnect the compressed air hose from the device.</p>

- Provide sufficient cartridge protection. We recommend using **30 grams** for each **square metre** of the **filter surface**. The cartridge protection is available at TEKA (see list of spare parts).
- Choose the capture point in the suction pipe that is the closest to the filter cartridges. E.g. an inspection flap can be used as a capture point.
- Switch the device on.
- Let the cartridge protection bit by bit be sucked in via the capture point.

7.7. Replacing the particle filter

Replacing the particle filter is necessary when the device control signals the corresponding error. (see chapter "Description of the control elements").



CAUTION

Whirling up dust is possible.

The particle filter is a disposable filter element. Do not try to clean the filter element.



The particle filter has the function of a police filter. This means that the filter is located behind the other filter elements according to the air flow direction. The police filter ensures that only clean air from the filter system flows back into the environment, even if one of the other filter elements is defective. The filter unit switches off when the police filter is saturated and can not be operated as long as the error message persists.

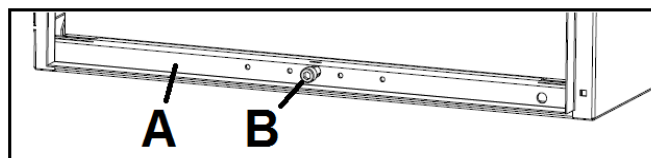

- Open the service door of the particle filter housing (see chapter 2.1).
- Release the two earth connections.



- Lower the lifting device (A) by turning the clamping screw (B).
- Carefully pull the entire filter pack, incl. the particle filter (see chapter 2.1) out of the housing. Before doing so the projecting measuring hose has to be separated from the intermediate frame.
- Replace the particle filter.
NOTICE Only use TEKA spare filters. Otherwise the proper functioning of the unit is not guaranteed, and there is a danger to life and limb.
- Push the filter pack back into the filter housing as far as it will go. Make sure that the filter elements are inserted in the correct order. Then reconnect the measuring hose at the intermediate frame.
NOTICE The seals of the particle filter, the activated carbon cassette and the intermediate frame must always be on the top.
- Elevate the lifting device by turning the clamping screw so that the upper filter element is pressed tightly against the above housing.

- Re-establish the two earth connections.

⚠ WARNING There is a risk of explosion during operation if an earth connection is not attached.



- Close the service door.

7.8. Replacing the activated carbon / the activated carbon cassette

The activated carbon absorbs gases and unpleasant odours. The activated carbon has to be replaced as soon as gases appear on the clean air side.

Therefore, replace the activated carbon in the activated carbon cassette. Alternatively, you can replace the entire activated carbon cassette. Different spare parts are required for these two options (see list of spare parts).



The saturation degree of the activated carbon is not monitored.

7.8.1. Replacing the activated carbon

- Open the service door of the activated carbon housing (see chapter 2.1).
- Release the two earth connections.



- Lower the lifting device (A) by turning the clamping screw (B).
- Carefully pull the entire filter pack, incl. the activated carbon cassette (see chapter 2.1), out of the housing. Before doing so the projecting measuring hose has to be separated from the intermediate frame.

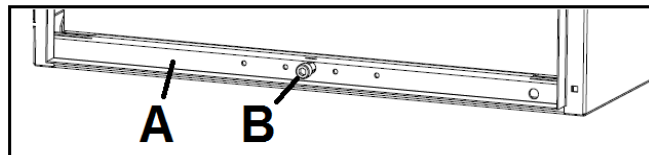

- Remove the cover of the activated carbon cassette. To do this, it is necessary to undo the screws.
(The activated carbon cassette shown in the illustration may possibly be of a different size to the one installed in your filter unit. However, the principle is identical.)
- Remove the top filter fleece mat.



<ul style="list-style-type: none"> Carefully empty the activated carbon. The used activated carbon must be emptied into an appropriate container and disposed of. 	
<ul style="list-style-type: none"> Remove the bottom filter fleece mat. Insert the new filter fleece mat here. This must completely cover the holes in the grille at the base. 	
<ul style="list-style-type: none"> The new activated carbon must be carefully filled into the activated carbon cassette. Gradually fill with a number of smaller quantities of activated carbon, spreading it out evenly and gently pressing down on it as you do so. <p>NOTICE Only use TEKA spare filters. Otherwise the proper functioning of the unit is not guaranteed, and there is a danger to life and limb.</p>	
<ul style="list-style-type: none"> The cassette must be filled with activated carbon up to the height of the support surface (A) and levelled off. Place the new top filter fleece mat over the activated carbon. It may be necessary to cut the filter fleece mat to the right size. The size must correspond to the dimensions of the cover. 	

- Screw the cover back on again. When you do this, the cover must press the top filter fleece mat against the support surface of the activated carbon cassette all the way round.



- Push the filter pack back into the filter housing. Make sure that the filter elements are inserted in the correct order. Then reconnect the measuring hose at the intermediate frame.

NOTICE The seals of the particle filter, the activated carbon cassette and the intermediate frame must always be on the top.

- Elevate the lifting device by turning the clamping screw so that the entire filter pack is pressed tightly against the above housing.
- Re-establish the two earth connections.

WARNING There is a risk of explosion during operation if an earth connection is not attached.



- Close the service door.

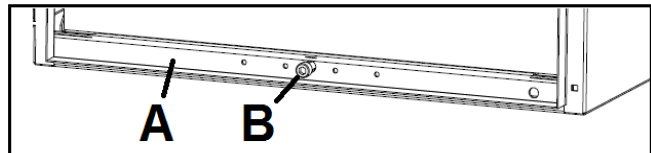

7.8.2. Replacing the activated carbon cassette

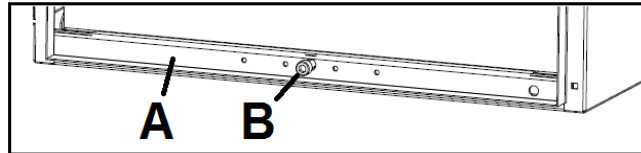

- Open the service door of the activated carbon housing (see chapter 2.1).
- Release the two earth connections.



- Lower the lifting device (A) by turning the clamping screw (B).
- Carefully pull the entire filter pack, incl. the activated carbon cassette (see chapter 2.1), out of the housing. Before doing so the projecting measuring hose has to be separated from the intermediate frame.
- Replace the activated carbon cassette.
NOTICE Only use TEKA spare filters. Otherwise the proper functioning of the unit is not guaranteed, and there is a danger to life and limb.
- Push the filter pack back into the filter housing. Make sure that the filter elements are inserted in the correct order. Then reconnect the measuring hose at the intermediate frame.
NOTICE The seals of the particle filter, the activated carbon cassette and the intermediate frame must always be on the top.
- Elevate the lifting device by turning the clamping screw so that the entire filter pack is pressed tightly against the above housing.
- Re-establish the two earth connections.

WARNING There is a risk of explosion during operation if an earth connection is not attached.



- Close the service door.

7.9. Replacing the cooling air filters of the turbines

The cooling air filters of the turbines must be checked regularly for pollution and they must be replaced when necessary (see list of spare parts).

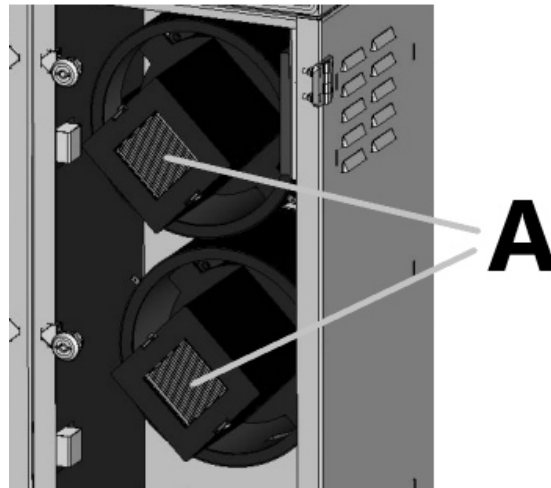

- Open the service door of the turbine housing. This is only possible by means of a special electrical spanner.
- Check the cooling air filters (A) for pollution. Replace them when necessary.
- Close the service door.

7.10. Replacing the filter mats for the air outlet grille

The filter mat is located in the ventilation grille of the control cabinet. The filter mat must be checked regularly and changed if necessary. This check depends on the degree of contamination. We recommend to stock with filter mats early on (see spare parts list).

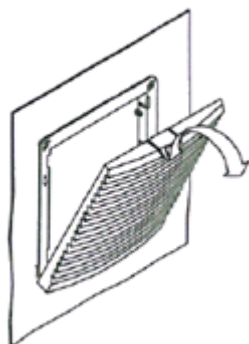

7.11. Cleaning/replacing the particle sensor



This section is only relevant, if the controller reports a "particle sensor" error message which persists after being acknowledged even though clearly no smoke is present. In such cases, it is probable that the particle sensor is too highly contaminated or faulty.

- The particle sensor is located inside the particle filter housing (see section 2.1).
- Remove the detector head from the assembly base. To do this, turn the detector head anticlockwise slightly.

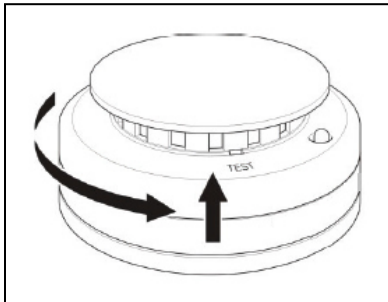

- Remove the cover. To do this insert a screwdriver and lift the cover. It is then necessary to pull the black cover off the smokebox.

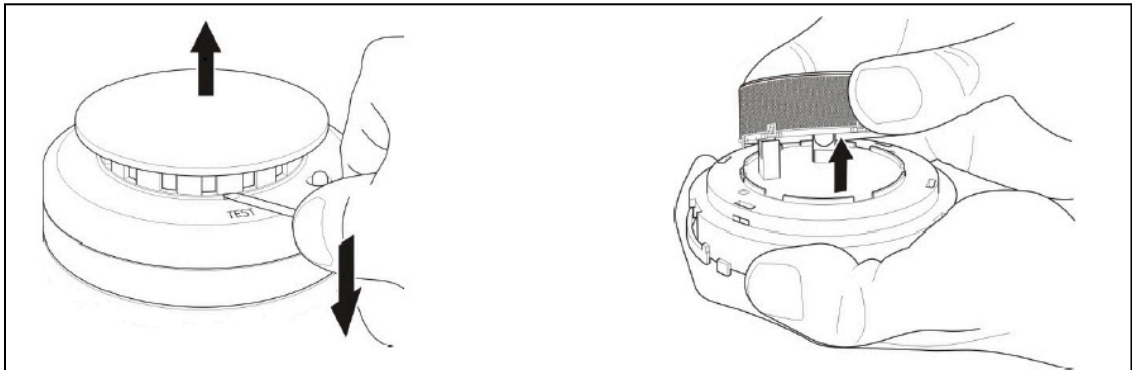

- Use compressed air to expel dust from the smokebox.
NOTICE Do not use a dust cloth.
- Mount the covers. Replace the detector head on the assembly base.

If the controller now still reports a "particle sensor" error message then the detector head must be replaced.

NOTICE Replacement parts are available from TEKA, see the spare parts list. In this case, it is not necessary to replace the assembly base which is screwed to the unit.

7.12. Check/replace the dust filters for underpressure measurement lines

Due to the accumulation of dust inside the filter housing, it is possible that dust may enter into any measurement lines. Each of the measurement lines is equipped with a dust filter to protect the measurement sensors against contact with dust. The dust filters are located inside the electronics housing. To access the dust filters, open the cover of the electronics area by undoing the four fixings.

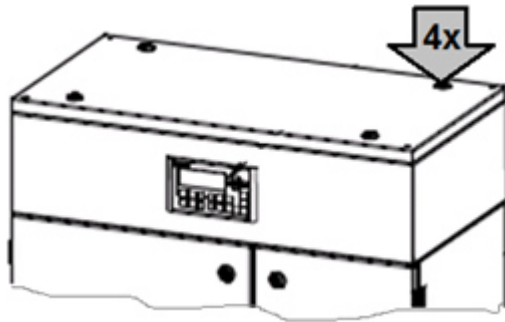

If too many dust particles are adhering to the white filter element then it is necessary to replace the filter element. The maintenance interval depends on the quantity of dust that arises and cannot therefore be determined in advance.



- The dust filter must be released from the measurement line. To do this, it is necessary to release the tubing connector on both the IN and the OUT sides.
- Insert the new dust filter in the measurement line. When you do this, make sure that it is installed in the right direction. This is indicated by the arrow, which must point away from the measurement sensor and towards the filter unit.

8. ATEX operation

The following ATEX zoning and ignition source analysis is applied to the filter unit.

8.1. ATEX zoning

Area	Ex zone	Reason/Cause
	Dusts	
Installation location (environment)	No zone	Installation not permitted in areas at risk of explosion, see: Intended use
Suction line - inside	Zone 20	Entry of dust via the extraction points / varying concentration
Raw gas area - inside	Zone 20	<ul style="list-style-type: none"> • Accumulation of dust due to the filter. • Disturbance of dust due to cleaning operations. • Entry of dust from the connected pipe
Clean gas area - inside	Zone 22	Potential filter breakthrough. Penetration of dust into the clean gas area.
Clean gas area (after police filter)	No zone	Penetration of dust is reliably excluded
Dust collecting container (1 m around the dust collecting container with projection onto the floor, including the installation area)	Zone 22	Dust collecting container is opened for emptying. This may briefly disturb the dust.

Dusts

No zone

Zone 20

Zone 21

Zone 22

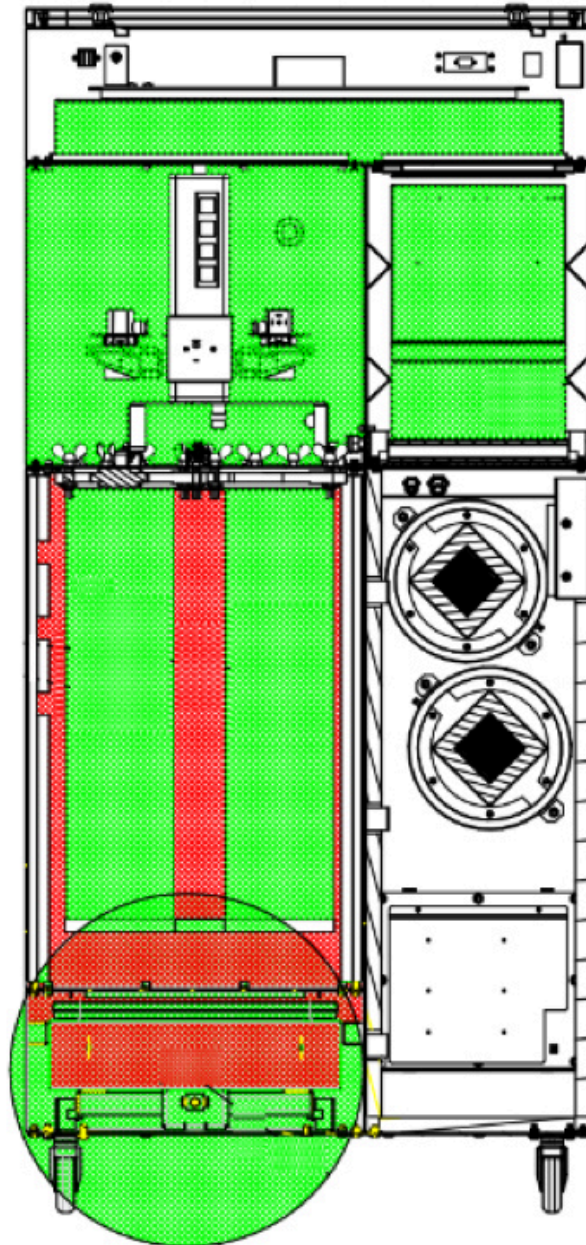

8.2. Sources of ignition

The operator of the filter unit must ensure that no effective sources of ignition enter the filter unit, such as

- a) Flames and hot gases,
- b) Mechanically generated sparks.



	WARNING
	<p>Explosion hazard! Externally entered effective sources of ignition can cause explosions.</p>

8.2.1. Evaluating the risk of ignition in accordance with DIN EN 80079-36

For the evaluation of the risk of ignition, see the Appendix.

9. Dismantling / Disposal

Only authorised personnel may disassemble the machine.

	WARNING
	<p>Dangers arising from electricity. Before the dismantling of the machine it has to be disconnected from the power supply and all supply lines.</p>
	<p>Explosion hazard due to dust formation. Avoid whirling up deposited dust during all maintenance work. Keep away possible ignition sources from the installation at any time. Use suitable tools to clean and to bond dust during cleaning work.</p>

	CAUTION
	<p>Whirling up dust is possible due to the deposited dust. During all work a suitable respiratory protection and protective clothing have to be worn.</p>

	<p>The operator is obliged to store and dispose of the collected dust in accordance with national or regional regulations.</p>
---	--

10. Diagnostics and troubleshooting

A list of possible system errors is provided in the table.

 Error messages of the control unit are described in the enclosed operating manual of the control unit.

A recommissioning of the device must only occur if it is ensured that the system is functionally equivalent to the original state. Repairs may only be carried out by TEKA personnel or, after consultation with TEKA GmbH, by the personnel authorised by the operator.

Adhere to the instructions in the chapter "Safety instructions" and "Maintenance" when carrying out any repairs. If in doubt, contact our TEKA service department:

Tel: +49 2541-84841-0

E-mail: info@teka.eu

Fault	Cause	Removal
System does not start.	Plug power supply is missing or incorrectly inserted.	Plug connector check power supply / plug in correctly.
	No power at outlet.	Check the mains, remove error if possible.
Dust at the dust collecting tank.	There is too much dust in the dust collection container.	Empty the dust collecting tank.
	The clamping lever has not been lift up.	Lift up the clamping lever.
	The seal of the dust collecting tank is damaged.	The seal must be replaced.
	The compressed air for the dedusting is set too high.	Reduce the compressed air.
Dust at the service door of the filter housing.	The door is not correctly closed.	Close the door.
	The seal between the service door and filter housing is damaged.	The seal must be replaced.
	The compressed air for the dedusting is set too high.	Reduce the compressed air.
	Escape of dust at the hinge.	The hinge must be reoriented or replaced.
Suction power too low (smoke hardly extracted).	Filter element is saturated.	Replace the filter package, dispose of old filter properly!
	Filter elements are saturated because no compressed air is connected.	Connect compressed air.

Fault	Cause	Removal
	Damage at the extraction elements.	Replace the extraction elements.
	Suction line contracted.	Check and fix.
	Exhaust line contracted.	Check and fix.
	Maybe throttle valves are used in the suction line.	Adjust throttle valves.

11. List of spare parts

	WARNING
<p>Dangers to life and limb when non-original spare parts are used. Only original TEKA spare parts must be used.</p>	

Filter element	Article no.
Filter cartridge, Type "easy clean nano - antistatic", 2,7m ² (Ø145 x 600 mm) (3 pieces of these filter elements are required for the device)	6160609302706
Particle filter "H13" (337 x 230 x 100)	100350004
Activated carbon cassette, 7,5 kg activated carbon (337 x 230 x 212), in the galvanized housing or: 7,5 kg activated carbon, including filter fleece mats	970591 100197310
Cooling air filter for turbine (62x62x48)	100350008
Filter mats for the air outlet grille (10 pieces)	5020007079
Dust filter for measuring tubes, for tubes Ø6 outer diameter	50310120093
Disposal elements	Article no.
PE-bag for the disposal of filter cartridges (6 pieces)	800000241
Cartridge protection	Article no.
Slack lime Ca(OH) ₂ "NANNOX L52" for filter cartridges, 3200g (in a bucket)	68130203200
Other parts	Article no.
Particle sensor (detector head)	999204

12. Technical data

Version		LFE 101 ST1	LFE 201 ST1	LFE 301 ST1	LFE 301 ST1
Supply voltage	V	115 / 230	230	115 / 230	230
Frequency	Hz	50 / 60	50 / 60	50 / 60	50 / 60
Type of current	Ph	1	1	1	1
Engine power	kW	1x 0,6	1x 1,2	2x 0,6	2x 1,2
Air flow volume max.	m³/h	280	250	400	500
Negative pressure max.	Pa	6300 / 7500	11000	6300 / 7500	11000
Protection class		IP54			
ISO class		F			
Extraction performance	%	>99			
Width	mm	751			
Depth	mm	400			
Height	mm	1590			
Weight	kg	ca. 168			
Sound pressure level	dB(A)	68			
Allowed ambient temperature	°C	+5 to +35 (during operations) -10 to +40 (during transport and storage)			
Max. temperature of polluted air at the capture point	°C	+50			
Allowed max. humidity	%	70			
Compressed air supply		dry / oil-free			
Necessary external pressure	bar	see chapter "Connecting the compressed air supply"			
Compressed air consumption	L/min	20			

13. EC declaration of conformity

according to the Machinery Directive 2006/42/EG, Annex II, 1 A

TEKA Absaug- und Entsorgungstechnologie GmbH

Millenkamp 9, D-48653 Coesfeld

Tel.: +49 2541-84841-0

E-Mail: info@teka.eu

Internet: www.teka.eu

Designation of the device: LFE 101 ST1 / LFE 201 ST1 / LFE 301 ST1

We hereby declare under our sole responsibility that the product mentioned above, from the serial number A22600010011001 resp. P57300010011001 on, conforms to the following directives:

Machinery directive: 2006/42/EC

Electromagnetic compatibility directive: 2014/30/EU

Pressure equipment directive: 2014/68/EU

RoHS directive: 2011/65/EU

This declaration will become void if the device is exposed to modifications that are not approved by the manufacturer in written form.

Authorized representative for the technical documentation:

TEKA Absaug- und Entsorgungstechnologie GmbH, Millenkamp 9, D-48653 Coesfeld

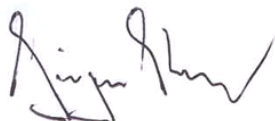

(Jürgen Kemper, managing director)

Coesfeld, 3rd January 2023

14. ATEX Annex to the EC declaration of conformity

We, TEKA Absaug und Entsorgungstechnologie GmbH, declare that the machine/system/components listed below comply with the relevant requirements of the



ATEX Directive 2014/34/EU, of the

German Hazardous Substances Regulation (GefStoffV) and the

German Law on Product Safety (ProdSG) concerning equipment and protective systems intended for use in potentially explosive atmospheres.

Filter unit type / Designation	LFE 101 ST1 / LFE 201 ST1 / LFE 301 ST1  II 1D/3D/- X
--------------------------------	---

14.1. ATEX devices

Designation:	Membrane solenoid valve (for filter cleaning) Type: 8296363.8176.02400
Identification:	  II 3D Ex tc IIIC T130°C Dc IP65
Manufacturer:	Buschjost GmbH Detmolder Straße 256 32545 Bad Oeynhausen Germany
ATEX conformity	Available

14.2. ATEX components

Designation:	Filter cartridge 2,7m ² antistatic Filter material FE2576 Art.Nr.:6160609302706
Manufacturer:	Freudenberg Filtration Technologies SE & Co. KG Höhnerweg 2-4 69469 Weinheim Germany
Suitability of filter material:	Acc. to manufacturer's certification: Freudenberg

This declaration will become void if the device is exposed to modifications that are not approved by the manufacturer in written form.

Authorized representative for the technical documentation:

TEKA Absaug- und Entsorgungstechnologie GmbH, Millenkamp 9, D-48653 Coesfeld

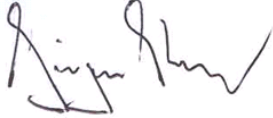
A handwritten signature in black ink, appearing to read 'Jürgen Kemper'.

(Jürgen Kemper, managing director)

Coesfeld, 3rd january 2023



15. Training protocol

Designation of the device: LFE 101 ST1 / LFE 201 ST1 / LFE 301 ST1

(This form can be used by the operator to document the training of the employees. Training should be performed by authorized personnel only. Refer to the instructions in Chapter "Safety Instructions")

By his signature, the employee confirms that he has been instructed regarding the following items:

Instruction	completed
Description of the device	
Operation and application of the device	
Explanation of the safety instructions	
Behavior in case of fire	
Explanation of the operation elements	
Change and dedusting of the filter elements	
Emptying of the dust collecting tank	
Appropriate disposal	
Maintenance works / Maintenance intervals	

Name of the employee (legible)	Signature

Introduction through (legible):	
Signature:	

16. Maintenance intervals

16.1. Usage-related maintenance

The described maintenances become necessary through the demands of the system operations. The maintenance intervals are recommendations. Depending on the application (multi-shift operation, dust generation, ...) it may make sense for the operator to change the intervals of maintenance, replacing and cleaning.

Maintenance work must always be documented by means of a protocol.

The approach of the maintenance measures is described in chapter "Maintenance".

Maintenance work	Chapter	Maintenance interval	
		recommended by TEKA	determined by the operator
Cleaning the filter cartridges	7.2	The cleaning of the filter cartridges is automatically carried out by the filter unit and thus is not subject to a maintenance interval.	
Replacing the filter cartridges	7.3	The saturation of the filter cartridges is automatically monitored by the filter unit and thus is not subject to a maintenance interval. The filter unit triggers an alarm when a replacement of the filter cartridges is necessary.	
Replacing the particle filter	7.7	The saturation of the particle filter is automatically monitored by the filter unit and thus is not subject to a maintenance interval. The filter unit triggers an alarm when a replacement of the particle filter is necessary.	
Emptying the dust collecting tank (or check of fill level)	7.4	weekly	
Draining the condensate	7.5	monthly	
Replacing the activated carbon / the activated carbon cassette (or check the degree of pollution)	7.8	when odours occur	
Replacing the cooling air filters of the turbines	7.9	semi-annually	
Check / Replacing the filter mat for the air outlet grille	7.10	semi-annually	
Check / Replacing the dust filters for the underpressure measurement lines	7.12	semi-annually	
Visual inspection of the pipelines for dust deposits	16.2.2	weekly	

16.2. General maintenance

The described maintenances are independent from the demands of the system operations.

The operator is obliged to carry out repeated inspections and functional tests according to national regulations. If not otherwise covered by national regulations, the described maintenance intervals must be respected.

Maintenance work must always be documented by means of a protocol.

Maintenance work	Chapter	Maintenance interval
Visual inspection of the device	16.2.1	weekly
Visual inspection of the pipelines for dust deposits	16.2.2	see chapter 16.1.
Visual inspection of the pneumatic pipes	16.2.3	monthly
Functional test of the device	16.2.4	monthly
Electrical test of the electrical lines and earthing connections	16.2.5	annually
Test of fixing of the mounted unit elements	16.2.6	annually

16.2.1. Visual inspection of the device

Visual inspection: Observation that there are no visible safety-related defects.

	WARNING
<p>Danger arising from the ready to operate condition of the device. Follow the procedure as described in the chapter "Set to maintenance state".</p>	

The following steps must be carried out in the course of the visual inspection:

- Check if all required pipeline elements, cable connections and hoses are connected to the filter unit
- Ensure that all parts are firmly connected.
- Check all connection points of the filter unit for escaping dust.
- Check all metal parts for corrosion or damages / changes of the coating.
- Check the inner filter area and the filter housing.
- Visual inspection of the control and operating elements as well as the outside running cables for damages.
- Check the dust collecting tank for tightness, check the sealing rubber of the tank.

16.2.2. Visual inspection of the pipelines for dust deposits

Visual inspection: Observation that there are no visible safety-related defects.

	WARNING Danger arising from the ready to operate condition of the device. Follow the procedure as described in the chapter "Set to maintenance state".
---	--

The following steps must be carried out in the course of the visual inspection:

- Open the inspection flaps of the pipeline and check the pipeline for dust deposits. Dust deposits must be eliminated.

16.2.3. Visual inspection of the pneumatic pipes

Visual inspection: Observation that there are no visible safety-related defects.

	WARNING Danger arising from the ready to operate condition of the device. Follow the procedure as described in the chapter "Set to maintenance state".
--	--

The following steps must be carried out in the course of the visual inspection:

- Open the service door of the cleaning housing .
- Carry out a visual inspection of the pneumatic parts.

16.2.4. Functional test of the device

	NOTICE Possible material damage due to faulty condition of the unit. Carry out a visual inspection before the functional test of the device as described in the previous chapters. The work as described in the chapter "Commissioning" must be finished.
---	--

The following steps must be carried out in the course of the functional test:

- Switch on the device.
- Pay attention to failures or error messages of the control unit. Also refer the separated operating manual of the control unit.
- Pay attention to extraneous noises or vibrations during the device's operation.
- Carry out a manual dedusting of the filter cartridges. Also refer to the separated operating manual of the control unit.
- Check if within one interval of the filter dedusting the number of dedusting shocks is equal to the number of filter cartridges (in each interval successively every filter cartridge becomes dedusted once).
- Check if dust is escaping from the unit during the dedusting cycle.

- A functional test should always be carried out with a connected / producing machine tool. Check if the collection of the fume or dust is sufficient. (Visual inspection).

16.2.5. Electrical test of the electrical lines and earthing connections

	WARNING
Danger arising from electricity. The operator is responsible for ensuring that all work on electric components is carried out by authorised and qualified personnel.	

The device is subject to regular electrical checks by the operator of the device, and are subject to national standards of the different countries.

The here recommended maintenance interval complies with the in Germany applying "Regulation 3 of the German Social Accident Insurance - Electrical plants and equipment" (formerly known as BGV-A3).

The check must only be carried out by a qualified electrician or a person trained in electrics using suitable measuring and test devices. The scope of testing and the methods must be in line with the respective national standard. All contacts in the control cabinet must be checked for tight fit, and must be readjusted if necessary.

The conductivity ($<10^6$ Ohm) of all parts that come into contact with dust (housing, suction pipe, filter cartridges, solenoid valves, etc.) must be checked annually using suitable measurement and test equipment. To do this, use the preprinted measurement report in Annex A.

16.2.6. Test of fixing of the mounted unit elements

The following steps must be carried out in the course of the inspection:

- Make sure that all elements that are connected at or with the unit are firmly fixed in place and have not come undone or loose. These also include all air-carrying lines, all extraction elements, bearing structures and frames.
- In the case of unit elements which are subject to vibrations and/or movements, the operator may need to define a shorter maintenance interval.

17. Annex A: ATEX conductivity measurement protocol

based on DIN EN 60079 -32 - 2

Machine No.: _____ Contact person: _____ Date: _____	Measurement performed by: _____ Signature: _____
Measurement instrument: Type: _____ last calibration: _____ Test number: _____	Environmental variables: Temperature: _____ Humidity: _____

Reference points for the individual measurements can be found in the table below.
A leakage resistance of $< 10^6 \text{ Ohm}$ must be achieved.

Measurement points: LFE 101 ST1 / LFE 201 ST1 / LFE 301 ST1

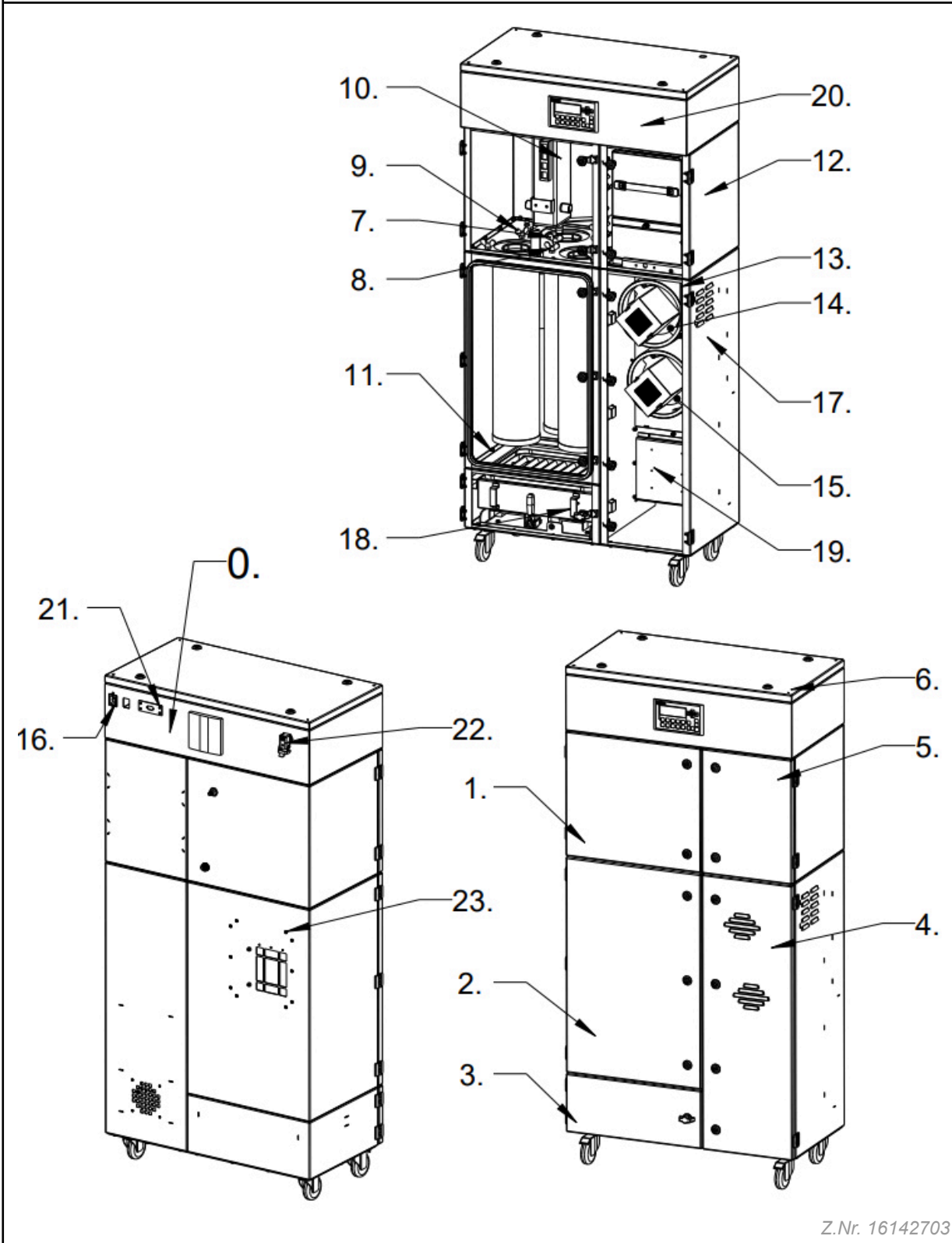

Z.Nr. 16142703

The air purifiers



measuring point	Measuring area / measurement points	Reference point	Measurement voltage [V]	Resistance [Ohm]	OK NOK
0.	<div style="display: flex; justify-content: space-between; align-items: center;"> <div style="flex: 1;"> <p>Point of equipotential bonding:</p> </div> <div style="flex: 1;">  </div> </div>				
1.	Door of cleaning housing	0. (Point of equipotential bonding)			
2.	Door of filter housing	0.			
3.	Door of dust collecting housing	0.			
4.	Door of turbine housing	0.			
5.	Door of particle filter housing	0.			
6.	Cover	0.			
7.	Wing nut 1	0.			
8.	Wing nut 2	0.			
9.	Wing nut 3	0.			
10.	Compressed air tank	0.			
11.	Filter housing (screw)	0.			
12.	Lateral guide	0.			
13.	Sound insulating plate	0.			
14.	Turbine mount 1	0.			
15.	Turbine mount 2	0.			
16.	IEC power connector	0.			
17.	Turbine housing	0.			
18.	Handle of dust collecting container	0.			
19.	Electronics plate	0.			
20.	Housing	0.			



21.	External control unit (screw)	0.			
22.	Industrial plug connector	0.			
23.	Connection point for suction housing (thread)	0.			

Measurement points: pipeline

The suction line must have continuous electrostatic conductivity from the individual extraction points to the filter device.
 This must be documented and confirmed using a measurement protocol. The following table can be used for this purpose. We recommend noting the measured measuring points (and if necessary also the reference points) in a drawing/photos.

measuring point	Measuring area / measurement points	Reference point	Measurement voltage [V]	Resistance [Ohm]	OK NOK

Evaluation of the risk of ignition based on DIN EN ISO 80079-36:2016-12



PROCEDURE NUMBER	--- (cross-project)	
MANUFACTURER	TEKA Absaug- und Entsorgungstechnologie GmbH Millenkamp 9 D-48653 Coesfeld	
DEVICE TYPE	LFE, version ST1	DEVICE GROUP II
DEVICE DESCRIPTION	The construction and intended use of the device are described in separate documentation (see Operating Instructions)	

Seq. No.	1 RISK OF IGNITION		2 EVALUATION OF FREQUENCY OF OCCURRENCE WITH NO ADDITIONAL MEASURES EMPLOYED				3 MEASURES EMPLOYED TO PREVENT EMERGENCE			4 FREQUENCY OF OCCURRENCE INCLUDING MEASURES						
	a	b	a	b	c	d	e	a	b	c	a	b	c	d	e	f
	POTENTIAL IGNITION SOURCE	CAUSE (Under what circumstances does the risk of ignition occur?)	IN NORMAL OPERATION	WHEN MALFUNCTION EXPECTED	ON INFREQUENT MALFUNCTION	NOT RELEVANT	REASON	DESCRIPTION	BASIS (standards, technical regulations, experimental results)	Technical Documentation (incl. the relevant properties listed in column 1)	IN NORMAL OPERATION	WHEN MALFUNCTION EXPECTED	ON INFREQUENT MALFUNCTION	NOT RELEVANT	RESULTING EPL FOR THIS IGNITION HAZARD	NECESSARY RESTRICTIONS
1	Flames and hot gases/particles	Flames/hot gases are introduced into the raw gas area via the pipeline	x				Process-related or error-related occurrence at the extraction point	Penetration into the filter must be excluded by the Operator.	TRGS 723 5.3 / DIN EN 80079-36 6.3	Restriction to Intended Use. Warning sections in chapter 2.3 and 8.2 of the Operating Instructions		x			Dc	
2	Mechanically generated sparks	Mech. generated sparks are introduced into the raw gas area via the pipeline	x				Process-related or error-related occurrence at the extraction point	Penetration into the filter must be excluded by the Operator.	TRGS 723 5.4 / DIN EN 80079-36 6.4	Restriction to Intended Use. Warning sections in chapter 2.3 and 8.2 of the Operating Instructions		x			Dc	
3	Electrical equipment	Magnet valves in the cleaning area	x				Magnet valves are a possible source of ignition	Only use devices that comply with the requirements for the defined ATEX zone and have the appropriate dust-related characteristic values. Here ATEX II 3D Ex tc IIIC T130 °C Dc Filter leakage monitoring by means of differential pressure monitoring for the filter class H13 safety filter	TRGS 723 5.5 / IEC 60079-26	Suitability based on CE certificate NORGREN / Buschjost diaphragm 8176		x			Dc	
4	Stray currents, cathodic corrosion protection	Return currents, lightning strike, earth fault	x				External sources can result in compensating currents that may cause ignition.	All housing parts that are in contact with dust are earthed	- TRGS 723 5.6.2 - DIN EN 80079-36 6.6.2	Confirm earthing measures in earthing report				x	Da	

Evaluation of the risk of ignition based on DIN EN ISO 80079-36:2016-12



PROCEDURE NUMBER	--- (cross-project)	
MANUFACTURER	TEKA Absaug- und Entsorgungstechnologie GmbH Millenkamp 9 D-48653 Coesfeld	
DEVICE TYPE	LFE, version ST1	DEVICE GROUP II
DEVICE DESCRIPTION	The construction and intended use of the device are described in separate documentation (see Operating Instructions)	

Seq. No.	1 RISK OF IGNITION		2 EVALUATION OF FREQUENCY OF OCCURRENCE WITH NO ADDITIONAL MEASURES EMPLOYED				3 MEASURES EMPLOYED TO PREVENT EMERGENCE			4 FREQUENCY OF OCCURRENCE INCLUDING MEASURES						
	a	b	a	b	c	d	e	a	b	c	a	b	c	d	e	f
	POTENTIAL IGNITION SOURCE	CAUSE (Under what circumstances does the risk of ignition occur?)	IN NORMAL OPERATION	WHEN MALFUNCTION EXPECTED	ON INFREQUENT MALFUNCTION	NOT RELEVANT	REASON	DESCRIPTION	BASIS (standards, technical regulations, experimental results)	Technical Documentation (incl. the relevant properties listed in column 1)	IN NORMAL OPERATION	WHEN MALFUNCTION EXPECTED	ON INFREQUENT MALFUNCTION	NOT RELEVANT	RESULTING EPL FOR THIS IGNITION HAZARD	NECESSARY RESTRICTIONS
5	Lightning strike	Lightning strike at or near the filter unit	x				Electrical charge or surfaces heated by lightning strike	Note in Operating Instructions. Inclusion of the installation in the lightning protection concept	- TRGS 723 5.8 - DIN EN 62305-1	Warning Section "Storage, transport and installation of the device" in the Operating Instructions				x	Da	
6	Static electricity	Isolated electrically conductive parts	x				Isolated conductive parts form a capacitor, e.g. through contact with statically charged dust	All housing parts that are in contact with dust are earthed and integrated in the equipotential earthing	- DIN EN 80079-36 6.7.2	Confirm earthing measures in earthing report				x	Da	
7	Static electricity	Spark discharge due to charging of coated housing parts	x				Accumulations of dust at internal housing parts	Electrically conductive coating of housing parts All housing parts that are in contact with dust are earthed	DIN EN 80079- 36 6.7.2 / measuring protocol and report DEKRA EXAM 15 EXAM 10556 BVS-BK	Confirm earthing measures in earthing report				x	Da	
8	Static electricity	Static discharge from a person while operating the system	x				Maintenance personal ist statically charged	Note in Operating Instructions.	- TRGS 727 7	Operating instructions, chapter "Maintenance"				x	Da	
9	Static electricity	Agglomeration of dust at the filter elements	x				Static discharge during cleaning operations	Use of conductive filter elements R< 10*6 Ohm and inclusion in the equipotential earthing	DIN EN 80079- 36 6.7.2	Confirm earthing measures in earthing report Proof of filter material				x	Da	

Evaluation of the risk of ignition based on DIN EN ISO 80079-36:2016-12



PROCEDURE NUMBER	--- (cross-project)	
MANUFACTURER	TEKA Absaug- und Entsorgungstechnologie GmbH Millenkamp 9 D-48653 Coesfeld	
DEVICE TYPE	LFE, version ST1	DEVICE GROUP II
DEVICE DESCRIPTION	The construction and intended use of the device are described in separate documentation (see Operating Instructions)	

Seq. No.	1		2				3			4						
	RISK OF IGNITION		EVALUATION OF FREQUENCY OF OCCURRENCE WITH NO ADDITIONAL MEASURES EMPLOYED				MEASURES EMPLOYED TO PREVENT EMERGENCE			FREQUENCY OF OCCURRENCE INCLUDING MEASURES						
	a	b	a	b	c	d	e	a	b	c	a	b	c	d	e	f
	POTENTIAL IGNITION SOURCE	CAUSE (Under what circumstances does the risk of ignition occur?)	IN NORMAL OPERATION	WHEN MALFUNCTION EXPECTED	ON INFREQUENT MALFUNCTION	NOT RELEVANT	REASON	DESCRIPTION	BASIS (standards, technical regulations, experimental results)	Technical Documentation (incl. the relevant properties listed in column 1)	IN NORMAL OPERATION	WHEN MALFUNCTION EXPECTED	ON INFREQUENT MALFUNCTION	NOT RELEVANT	RESULTING EPL FOR THIS IGNITION HAZARD	NECESSARY RESTRICTIONS
									Resulting EPL including all existing risks of ignition					Dc		